



# INSTALLATION GUIDE

## THORNOVA PHOTOVOLTAIC MODULE

Bifacial Dual Glass Module - 20221122



# Bifacial USER MANUAL

Bifacial User Manual .....	1
1. INTRODUCTION FOR USER ANUAL.....	2
1.1 DISCLAIMER .....	2
1.2 LIMITATION OF LIABILITY .....	2
2. SAFETY PRECAUTIONS .....	2
2.1 WARNING .....	2
2.2 GENERAL SAFETY .....	2
2.3 HANDLING SAFETY .....	2
3. UNLOAD / TRANSPORTATION / STORAGE.....	3
3.1 MAKERS ON OUTER PACKAGING .....	3
3.2 UNLOADING WARNING .....	4
3.3 SECONDARY TRANSPORT AND WARNING .....	5
3.4 STORAGE .....	6
4. UNPACKING INTRODUCTION .....	6
4.1 UNPACKING SAFETY .....	6
4.2 UNPACKING STEP .....	6
5. INSTALLATION .....	8
5.1 INSTALLATION SAFETY .....	8
5.2 INSTALLATION METHOD .....	8
5.2.1 MECHANICAL INSTALLATION AND WARNING .....	8
5.2.2 GROUNDING .....	8
5.2.3 ELECTRICAL INSTALLATION .....	16
6. MODULE MAINTENANCE FOR PV MODULE PV .....	17
6.1 PANEL VISUAL INSPECTION AND REPLACEMENT.....	17
6.2 CONNECTOR AND CABLE INSPECTION.....	18
6.3 CLEANING .....	18
6.3.1 MODULE INSPECTION AFTER CLEANING .....	19
6.3.2 TROUBLESHOOTING .....	19
Attachment 1: SITE SELECTION and Title Angle .....	19
Attachment 2: INVERTER SELECTION AND COMPATIBILITY.....	20

## 1. INTRODUCTION FOR USER MANUAL

This Manual applies to the installation, maintenance and use of the bifacial solar modules manufactured by Thornova Solar Ltd. (hereinafter referred to as “Thornova Solar”). Failure to follow these safety instructions could result in personal injury or property damage.

Installation and operation of solar modules require specialized skills, and only professional personnel can engage in the work. Please read the “Safety and Installation Instructions” carefully before using and operating the modules. The installer must inform the end customer (or consumer) of the above matters accordingly.

The term “Module” or “PV Module” in this Manual refers to one or more bifacial solar modules. Please keep this Manual for future reference.

### 1.1 DISCLAIMER

Thornova Solar reserves the rights to change this installation Manual without prior notice. Failure of the customer to follow the requirements outlined in this Manual during the installation of the module will result in the invalidity of product's limited warranty

### 1.2 LIMITATION OF LIABILITY

Thornova Solar is not responsible for any form of damage, including but not limited to module operation and system installation error, and personnel injury, hurt, and property loss resulting from failure to follow the instructions in this Manual.

## 2. SAFETY PRECAUTIONS

### 2.1 WARNING

Before installing, wiring, operating, or maintaining Thornova Solar modules, you should read and understand all safety precautions. Direct current (DC) is generated when the cells surface of the module is exposed to direct sunlight or other light sources, and direct contact with the live parts of the module, such as terminals, may result in death of personnel whether connected to the module or not .

### 2.2 GENERAL SAFETY

All installation work must comply with the local codes and the relevant international electrical standards.

Thornova Solar recommends that PV module installation is conducted by personnel with experience in PV system installation. Operation by personnel who are not familiar with the relevant safety procedures will be very dangerous.

Do NOT allow unauthorized persons to access the installation area or module storage area.

Do NOT install modules with damaged glass

Do NOT disassemble or move any part of the module.

Do NOT artificially focus light on the module.

Do NOT connect or disconnect the module when it is energized or connected with an external power supply

### 2.3 HANDLING SAFETY

Do NOT stand, walk on or lean on the module directly.



Do NOT damage or scratch the front or backside surfaces of the module.

Do NOT scratch the output cable or bend it with force. The insulation of output cable can break and may result in electricity leakage or shock.

Do NOT use water to extinguish fires of an electrical origin.

Do NOT install or handle modules when they are wet or during periods of high wind. At the installation

site, take care to keep modules and in particular their electrical contacts, clean and dry before installation. If connector cables are left in damp conditions then the contacts may corrode. Any module with corroded contacts should not be used.

Please do NOT loosen or unscrew the PV module bolts. This may lead to a reduction of the module's load rating and potential damage from a fall.

Do NOT drop PV modules or allow objects to fall down on the PV modules.

Do NOT touch the terminal box or the ends of the output cables (connectors) with bare hands under sunlight, regardless of whether the PV module is connected to or disconnected from the system.

### 3. UNLOAD / TRANSPORTATION / STORAGE

Precautions and general safety rules:

The modules should be stored in the original Thornova Solar package before installation. Protect the package from damage. Unpack the modules as per the recommended unpacking procedures. The whole process of unpacking, transport and storing should be handled with care;

Do NOT stand, climb, walk or jump on unpacked pallets of modules;

Before installation, ensure that all modules and electrical contacts are clean and dry;







If the modules are required to be stored temporarily, they should be stored under dry and ventilated conditions;

Unpacking must be carried out by two or more persons at the same time. It is forbidden to use the wires or junction boxes of the modules to carry the modules. Handling the modules requires two or more people with non-slip gloves; Do NOT handle the modules over-head or stack the modules;

Do NOT put the modules in a place that is not supported or stable;

Do NOT allow the modules to come in contact with sharp-pointed objectives to prevent them from scratches, avoiding a direct impact on the safety of modules.

#### 3.1 MAKERS ON OUTER PACKAGING

<p>3.1.1 Do NOT discard the modules at will; special recycling is required</p>  <p>EU-28 WEEE COMPLIANT</p>	<p>3.1.2 Modules must be kept dry, not expose to rain or moisture</p> 
<p>3.1.3 Modules in carton are fragile, which must be handled with care</p> 	<p>3.1.4 The packaging must be transported upright</p> 
<p>3.1.5 Do NOT step on the package and module</p> 	<p>3.1.6 The carton can be recycled</p> 

## 3.1.7

Modules shall be stacked as required, not exceeding the maximum number of layers printed on the outer packaging. (  $n = 2$  means no more than two layers and  $n = 3$  means no more than three layers)

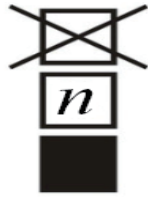

## 3.1.8

One module shall be handled by at least two persons together

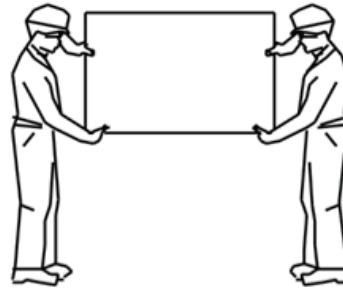

## 3.1.9

When the carton box is loading and unloading in the transportation.  
Attention: Prevent collision on the top



## 3.2 UNLOADING WARNING

3.2.1 Use the correct (as picture) lifting fixture to handle, no more than 2 pallets per lift. Before lifting, please confirm the tray and the carton are NOT damaged and the hoisting rope is firm and solid. Before lowering the carton back on the ground, two persons must support the two sides of the carton gently to put it on a relatively flat place.

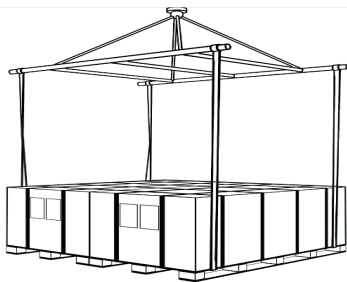

3.2.2 If the condition permits, use a fork lift to remove the module pallets from the truck

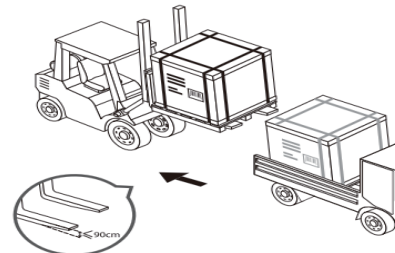

Put the modules on level ground

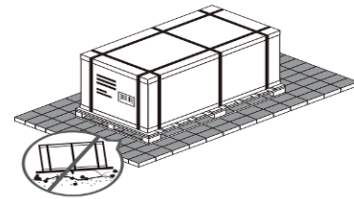

3.2.3 Store the module in a dry and ventilated place

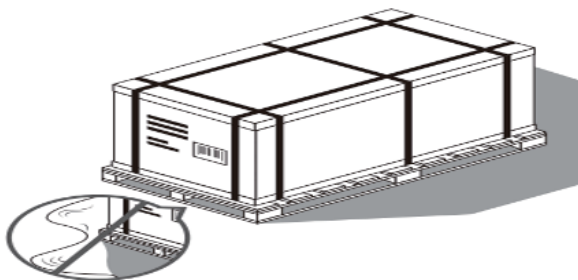

3.2.4 Do Not stack the modules at the project site.

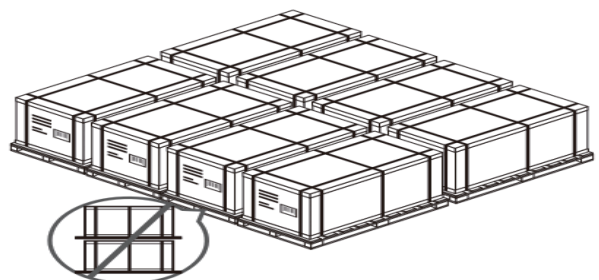

3.2.5 Cover all of parts of the package with waterproof material to prevent the panel package and plate from moisture.

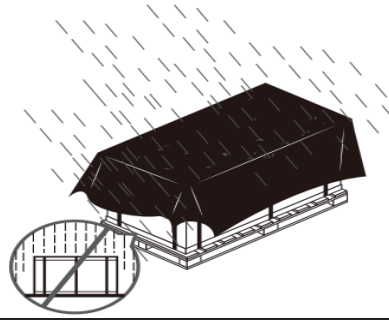

### 3.3 SECONDARY TRANSPORT AND WARNING

3.3.1 Do NOT remove the original packaging if the modules require long-distance transport or long-term storage.

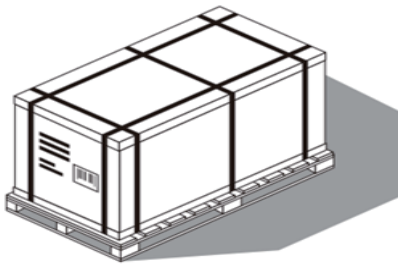

3.3.2 The finished package can be transported by land, sea or air. During transport, make sure that the package is fixed with packing straps securely to the shipping platform without movement.

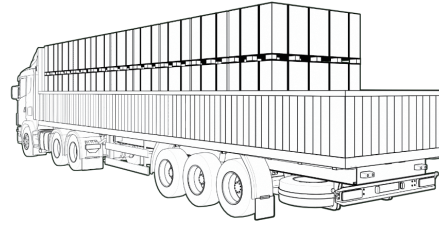

3.3.3 Transport: Do Not Stack more than two layers on truck;

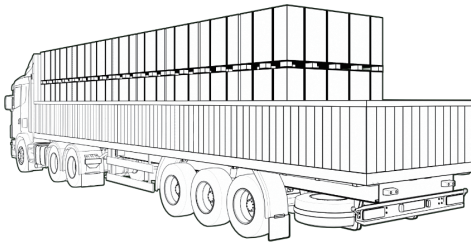

3.3.4 Only one layer stacking is only allowed for small truck. Make sure that the package is fixed with packing straps securely to the shipping platform without movement.

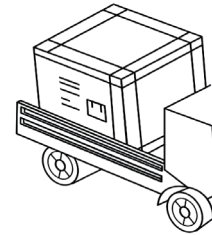

3.3.5 Only one layer stacking is only allowed for transport at the project site

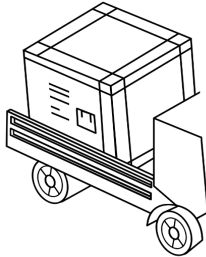

3.3.6 No transport or handling by pedi-cab as shown below;

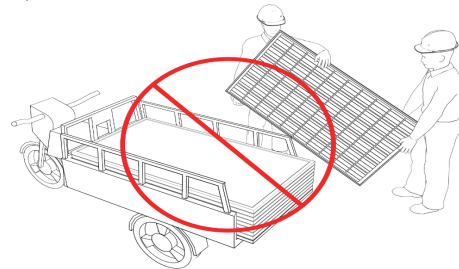

3.3.7 Do Not transport the module with rope as shown below:

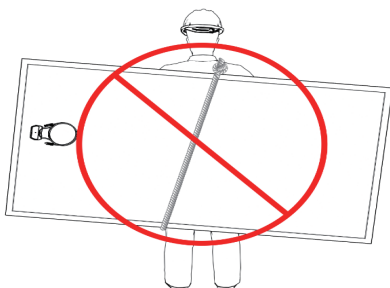

3.3.8 Do Not carry the modules on the back of one person as shown below:

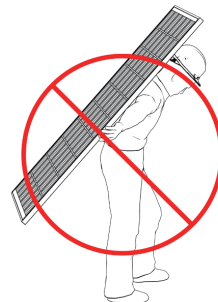

### 3.4 STORAGE

Long-term storage in warehouse

Do NOT remove the original packaging if the module requires long-distance transport or long-term storage.

Do NOT expose the modules to rain or moisture. Store the finished product in a well ventilated, waterproof, dry and smooth place.

Storage: Do Not Stack more than 2 layers (moisture < 85%, temperature range from -20°C to + 50 °C)

Storage in project site:

The module must be installed as soon as possible in the project site and must not be exposed to rain or damp. Thornova Solar shall not be responsible for any damage or collapse of the modules caused by moisture in the packaging.

## 4. UNPACKING INTRODUCTION

### 4.1 UNPACKING SAFETY

For unpacking outdoors, it is prohibited to operate in rainy conditions. Because the carton will become soft and damaged after it gets wet in the rain. The stacked PV modules (hereinafter referred to as "modules") may tip over, which may cause damage or injury to personnel.

For a windy site, it is necessary to pay special attention to safety. Especially, it is NOT recommended to transport the modules in high wind conditions. The unpacked modules must be tied down to avoid any unwanted movement.

The work surface is required to be level to ensure that the package can be placed stably, avoiding sliding.

Wear protective gloves during unpacking to avoid hand injury and fingerprints on the glass surface.

Module information and unpacking instructions can be found on the outside of each package. Please read the instructions before unpacking.

Each module shall be handled by two persons. It is forbidden to use the wires or junction boxes of the modules to carry the module. Do Not take the module out of the carton by pulling on the long side frame.

### 4.2 UNPACKING STEP of FRAMED DUAL-GLASS MODULE SERIES

**Method A:** Unpacking for modules with vertical package.

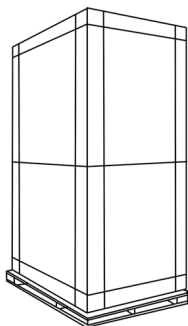

1) Remove the wrapping film and packing belts.

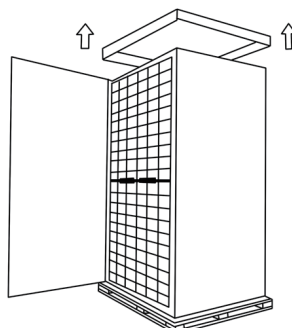

2) Remove the top cover and sealing tape.

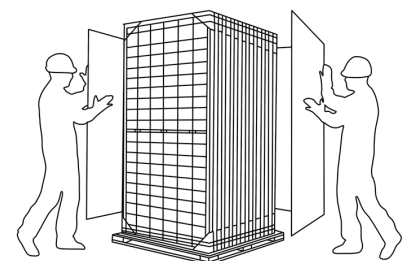

3) Remove the carton box.

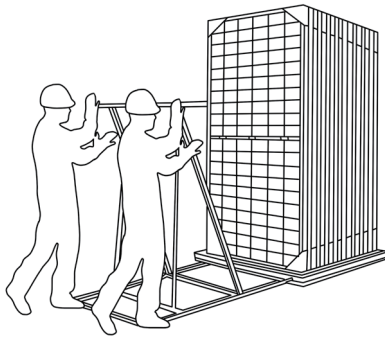

4) Place the stand supporter from the glass or backsheet side.

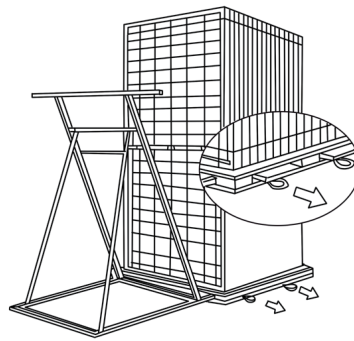

5) Pull out the 4 levers from both sides of the pallet.

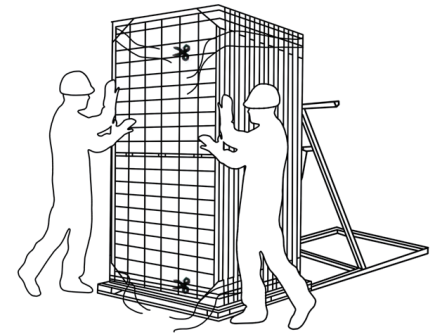

6) Cut off all the horizontal packing belts.

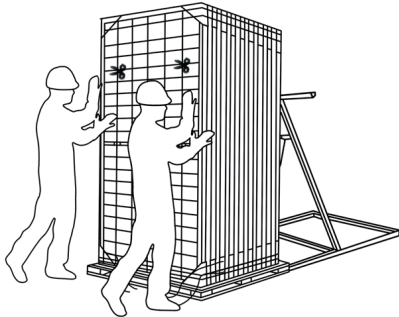

7) When there are 1-2 vertical packing belts remaining, push the module gently to tilt toward the stand supporter.

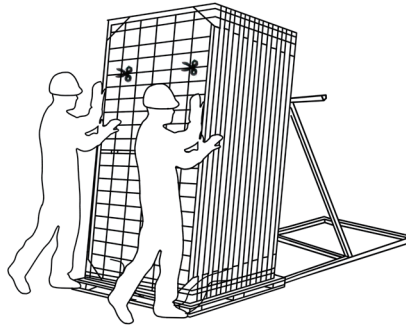

8) Cut off the remaining packing belts so that the modules rest on the stand supporter.

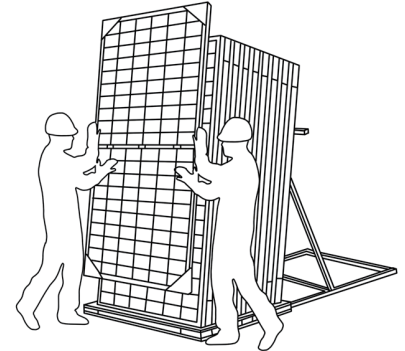

9) Take out the modules in order.

### Method B: Unpacking for vertical landscape package

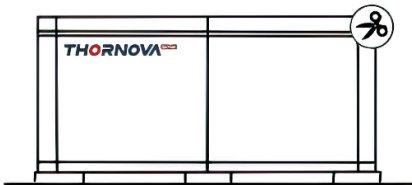

1) Remove the wrapping film and packing belts.

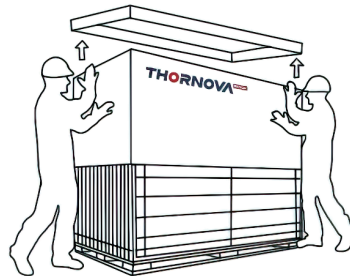

2) Remove the top cover and the cartons.

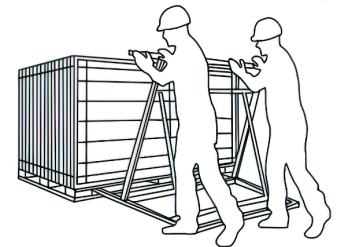

3) Place the stand supporter that is higher or wider than the module in order to avoid hitting and damaging the glass.

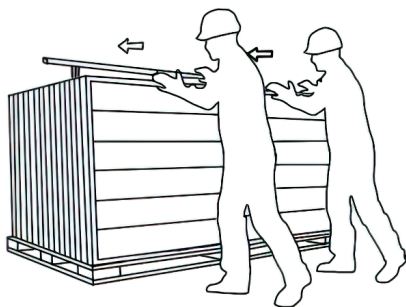

4) Cut off all the horizontal packing belts; when there are 1 or 2 vertical packing belts remaining, push the module gently to tilt toward the stand supporter.

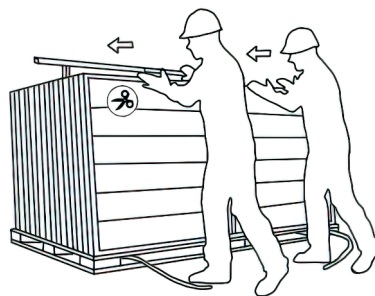

5) Cut off the remaining packing belts.

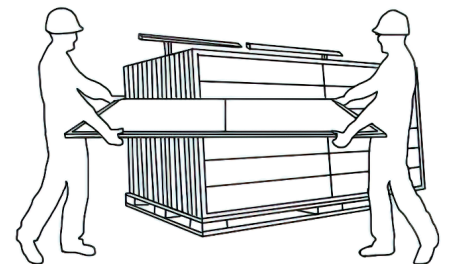

6) Take out the modules in order.



## 5. INSTALLATION

Thornova Solar bifacial modules may be installed in extreme environmental conditions to produce energy for more than 30 years. Thornova Solar products have also been tested to verify resistance to ammonia fumes that may be present around barns sheltering cattle, as well as suitability for installation in humid (coastal) areas and areas of high sand storms (desert).

### 5.1 INSTALLATION SAFETY

Thornova Solar Modules can be mounted in landscape or portrait orientation however the impact of dirt shading the solar cells can be minimized by orienting the product in landscape.

Always wear dry insulation protection equipment: insulated tools, head gear, insulated gloves, safety belt and safety shoes (with rubber soles).

Do NOT wear metallic jewelry which can cause electric shock during installation.

Do NOT install modules under rain, snow or windy conditions.

Please keep the connector dry and clean during installation to avoid the risk of electric shock. It is recommended to install it immediately after unpacking.

Due to the risk of electrical shock, do NOT perform any work if the terminals of PV module are wet. Please install immediately after unpacking.

Our module application class is class A, modules rated for use in this application class may be used in systems operating at greater than 50V DC or 320W, where general contact access is anticipated;

Keep the PV module packed in the Thornova Solar carton until installation.

Please use an opaque material to completely cover the PV module surface during PV module installation and wiring.

Do NOT unplug the connector if the system circuit is connected to a load.

Do NOT stand on the module glass while installing. There is a risk of injury or electric shock if glass is broken.

Do NOT work alone (always work as a team of 2 or more people).

Do NOT damage the back glass of PV modules when fastening the PV modules to a support with bolts.

Do NOT damage the surrounding PV modules or mounting structure when replacing a PV module.

Cables shall be located and secured so that they will not be exposed to direct sunlight after installation to prevent degradation of cables. Low drooping of cables from the terminal box must be avoided. Low hanging cables could cause various problems such as animal biting, electricity leakage in water, and fire.

Modules with different color codes are not recommended to be installed in one block or the same rooftop.

Protective measures must be taken in the process of installation to avoid force extrusion or impact on the modules, especially in areas with a 25mm edge around the modules.

The design loading of modules have been evaluated by TUV according to IEC61215 with 1.5 times safety factor; The mechanical load bearing is dependent upon the mounting methods used and failure to follow the instructions of this manual may result in different capabilities to withstand snow and wind loads; The system installer must ensure that the installation methods used meet these requirements and any local codes and regulations.

### 5.2 INSTALLATION METHOD

#### 5.2.1 MECHANICAL INSTALLATION AND WARNING

The connection of the module to the racking system can be created with clamps, with frame, or an embedded system on the frame. The modules must be installed according to the following examples and recommendations. If a different installation method is desired, please contact Thornova Solar customer service or technical support team for consultation. Improperly mounted modules maybe damaged. If alternative mounting method is used that has not been approved by Thornova solar, the modules will not continue to carry a valid warranty.

Panels must not be subjected to wind or snow loads exceeding the maximum permissible loads, and must not be subjected to excessive forces due to the thermal expansion of the support structures.

The module frame drain holes cannot be blocked in any situation during installation or use.

To maximize mounting longevity, Thornova Solar strongly recommends the use of corrosion proof (stainless steel) attachment hardware.

#### A. Mounting with Bolts 4- $\phi$ 9\*14mm mounting holes

Modules can be attached using the mounting holes 4- $\phi$ 9\*14mm on the back of the module frame, by fixing the module to the support rails with bolts. The mounting details are shown in the following figures.

The frame of each module has 4- $\phi$ 9\*14mm mounting holes, ideally placed to optimize the load handling capability, to secure the modules to the supporting structure. Installation holes of 4- $\phi$ 9\*14 mm are used for installation, as shown in Figure 4

To maximize mounting longevity, Thornova Solar strongly recommends the use of corrosion proof (stainless steel) attachment fixings.

Secure the module in each mounting location with an M8 bolt and a flat washer, spring washer and nut and tighten to a torque of 16~20 N.m (140-180lb.in.).

All parts in contact with the modules should use flat stainless steel washers of minimum 1.5mm thickness with an outer diameter of 20-24mm (0.79-0.94in).

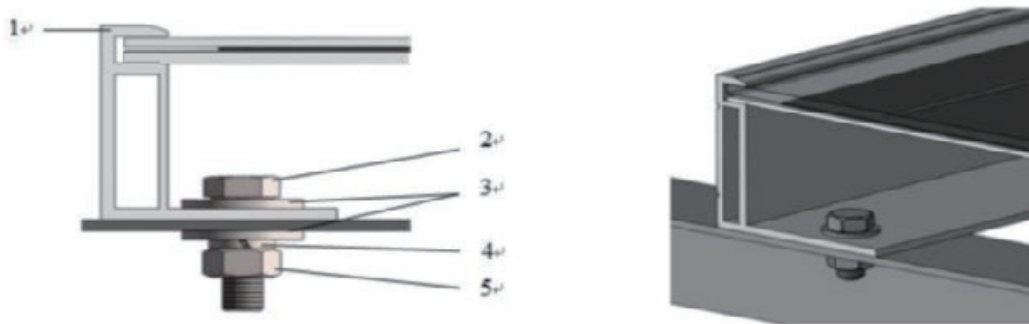

**Fig.4 Bifacial module with frame**

1.aluminum frame

2.M8 stainless bolt

3.flat stainless washer

4.spring stainless washer

5.hex stainless nut

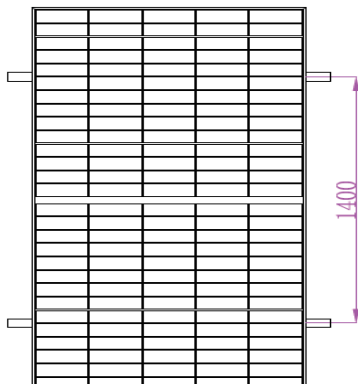
Module	Mechanical Load Pressure	Safety factor	Mounting Direction
Bifacial Module	+3600 Pa / -1600Pa	1.5	 <p>*NOTE: 1. This installation may cause the cell covered, so Thornova Solar does not recommend this installation for Bifacial Dual Glass Module.</p>

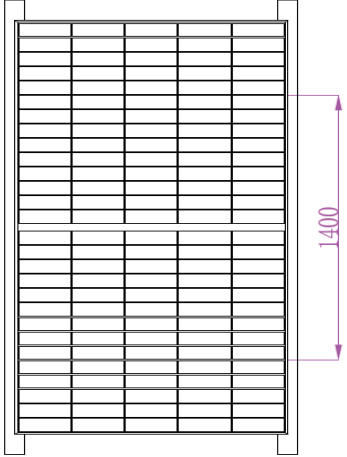
			<p>2. The above-described distance is from the middle of the bolts to the middle of the bolts</p> <p>3. The crossbeam is perpendicular to the long side</p> <p>4. Need two support rails below the PV module to make sure the Mechanical load.</p> <p>5. The actual load is + 5400Pa/-2400Pa;</p>
Bifacial Module	+3600 Pa / - 1600Pa	1.5	 <p>*NOTE:</p> <ol style="list-style-type: none"> <li>1. The above-described distance is from the middle of the bolts to the middle of the bolts.</li> <li>2. The beam is parallel to the long side.</li> <li>3. Need two support rails below the PV module to make sure the Mechanical load.</li> <li>4. The actual load is + 5400Pa/-2400Pa</li> </ol>

## B. Mounting with Clamps

Thornova Solar has tested its modules with a number of clamps from different manufacturers, with a mounting bolt of at least M8. The length of clamp  $\geq 60\text{mm}$  (2.36in), thickness  $\geq 3\text{mm}$  (0.12in), Material: 6005 T5 / T6 ( $R_m \geq 255\text{ MPa}$ ,  $R_{p0.2} \geq 230\text{ MPa}$ ).

The clamp must overlap the module frame by at least 7mm (0.28in) but no more than 10mm (0.39in).

Use at minimum 4 clamps to attach modules to the mounting rails.

Modules clamps should not come into contact with the front glass and must not deform the frame.

Be sure to avoid shadowing effects on the solar cells from the module clamps.

The module frame is not to be modified under any circumstances.

When choosing this type of clamp-mounting method, use at least four clamps on each module, two clamps should be attached on each long sides of the module (for portrait orientation) Depending on local wind and snow loads, additional clamps may be required to ensure that modules can bear the load.

Applied torque should refer to mechanical design standard according to the bolt customer is using, ex: M8 ---- 16-20 N.m (140-180lbf.in)

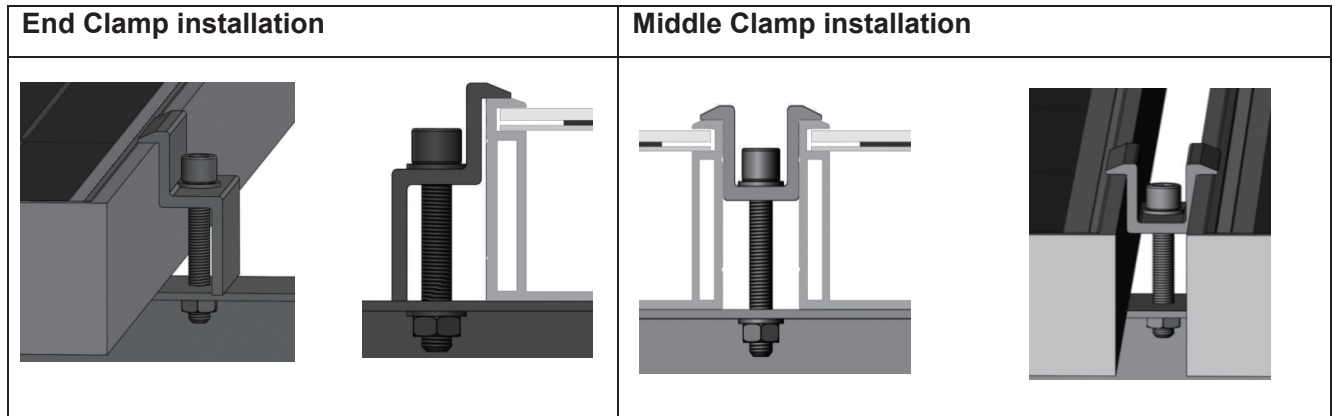

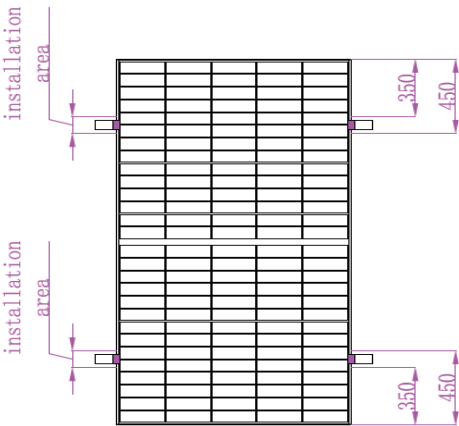
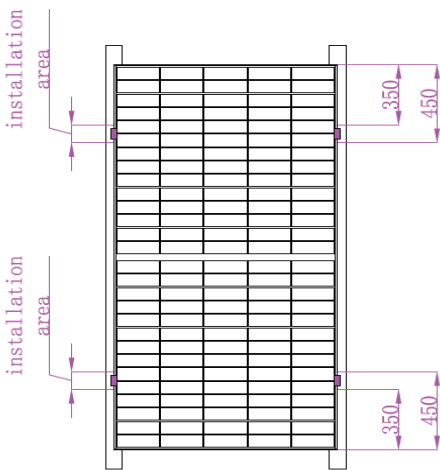
Module	Mechanical Load Pressure	Safety factor	Mounting Direction
Bifacial Module	+3600 Pa / - 1600Pa	1.5	 <p><b>*NOTE:</b></p> <ol style="list-style-type: none"> <li>1. This installation may cause the cell covered, so Thornova Solar does not recommend this installation for Bifacial Dual Glass Module.</li> <li>2. The above described distance is from the module edge to the middle of the clamp.</li> <li>3. The crossbeam is perpendicular to the long side</li> <li>4. Need two support rails below the PV module to make sure the Mechanical load.</li> <li>5. The actual load is + 5400Pa/-2400Pa;</li> </ol>
Bifacial Module	+3600 Pa / - 1600Pa	1.5	 <p><b>*NOTE:</b></p> <ol style="list-style-type: none"> <li>1. The above described distance is from the module edge to the middle of the clamp.</li> <li>2. The beam is parallel to the long side.</li> <li>3. Need two support rails below the PV module to make sure the mechanical load.</li> <li>5. The actual load is + 5400Pa/-2400Pa;</li> </ol>

\*Note1: The above-described distances are from the module edge to the middle of the clamp.

\*Note2: Need two or more support rails below the PV module to ensure the mechanical load.

If the customer needs a different size of Clamps, it should be fully evaluated and approved by Thornova

### C. Mounting with Single-axis Tracking System with 4- $\phi 7*10$ mm mounting holes

- It is a Single-axis Tracking System, the module is fixed on the axis by bolting long frame.
- The frame of each module has 4- $\phi 7*10$ mm (0.28\*0.39in.) mounting holes with specific location shown in Figure 5.
- Secure the module in each fixing location with an M6 bolt, two flat washers, a spring washer and nut as shown in Figure 5.
- If a different bolt similar to M6 is used, they need to be tightened to a torque of 16N.m (140lbf.in).
- All parts in contact with the frame should use flat stainless steel washers of minimum 1.5mm thickness with an outer diameter of 16-20mm (0.63-0.79in.).
- The bolt should be made of stainless steel or the other anti-corrosion material.
- Mechanical Load Pressure under this method: 30 lbs.ft<sup>2</sup> max from the front side & 30 lbs.ft<sup>2</sup> max from the rear according to UL1703.

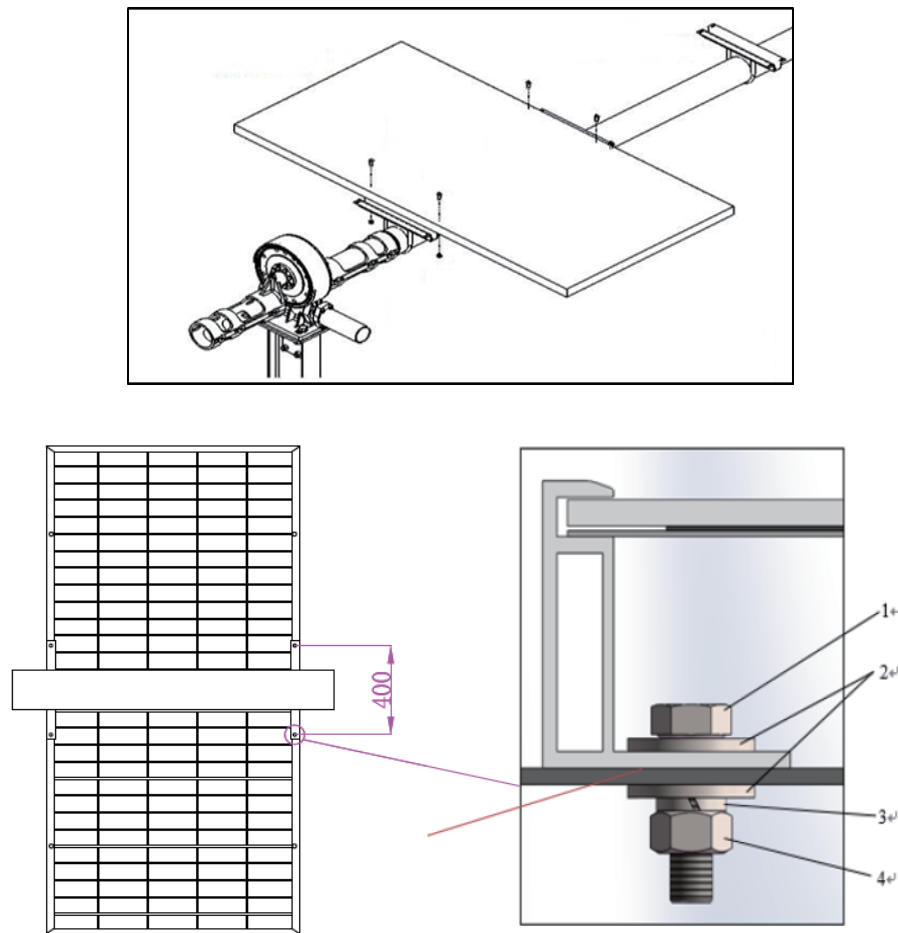

**Fig 5. PV module installed with Single-axis Tracking System**

- 1) M6 Stainless hex bolt
- 3) Spring stainless washer

- 2) flat stainless washer
- 4) hex stainless nut

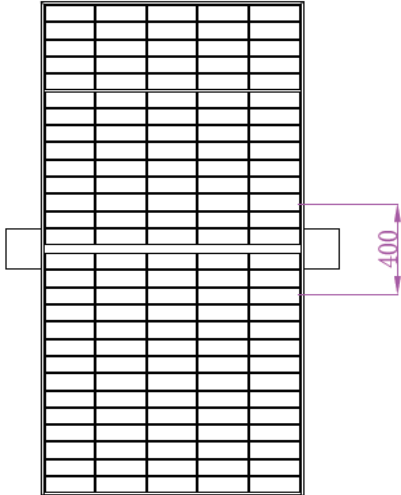
Module	Mechanical Load Pressure	Safety factor	Mounting Direction
Bifacial Module	+1600 Pa /-1600 Pa	1.5	 <p>*NOTE:  1. This installation may cause the cell covered, so Thornova Solar does not recommend this installation for Bifacial Dual Glass Module.  2. The above-described distance is from the middle of the bolts to the middle of the bolts.  3. The actual load is + 2400Pa/-2400Pa</p>

## THORNOVA SOLAR FRAME COMPATIBILITY WITH VARIOUS RACKING SYSTEMS.

The following examples illustrate how to evaluate Thornova Solar Frame compatibility with various racking systems.

- Please pay attention to the size from component battery to the edge of the frame, and the bracket or pad shall not obscure the battery
- Please note that the connection location should be reserved for bracket under the grounding hole.



Example A: zigzag racking installation

- When selecting zigzag steel, please confirm the structural strength of profiles.
- When selecting zigzag steel, please confirm the size and the hole position of it so that the gaskets, washers and screws can be installed.
- Please press the waist type wind hole at the bottom of zigzag steel.



#### Example C: C structure steel type 1 racking installation

- When selecting C structure steel, please confirm the structural strength of pads.
- When selecting C structure steel, please confirm the size and hole position of pads so that the gaskets, washers and screws can be installed.
- For C structure steel type 1 racking, due to the amount of space inside the racking section, many choices are available including T-shape nuts.

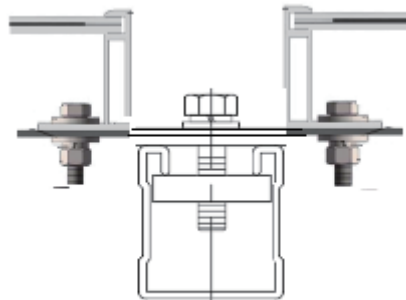

### 5.2.2 GROUNDING

All module frames and mounting racks must be properly grounded in accordance with appropriate respective National Electrical Code.

Proper grounding is achieved by bonding the module frame(s) and all metallic structural members together continuously using a suitable grounding conductor. The grounding conductor or strap may be copper, copper alloy, or any other material acceptable for use as an electrical conductor per respective National Electrical Codes. The grounding conductor must then make a connection to earth using a suitable earth ground electrode.

Thornova Solar modules can be installed with the use of third party listed grounding devices for grounding the metallic frames of PV modules. The devices have to be installed in accordance with the grounding device manufacturer's specified instructions.

Please refer to the "Product Catalogue" link for detailed grounding hole locations and size at <http://www.thornovasolar.com>

- Grounding hardware comes in a package that includes the grounding screw, flat washer、star washer and wire
- Electrical contact is made by penetrating the anodized coating of the aluminum frame, and tightening the mounting screw (come with the star washer) to the proper torque of 25lbf.in.
- Grounding wire size (6 to 12 AWG solid bare copper) should be selected and installed underneath the wire binding bolt.

Star washer, flat washer, grounding wire are placed in turn, then screwed into the grounding hole to bond the adjacent modules

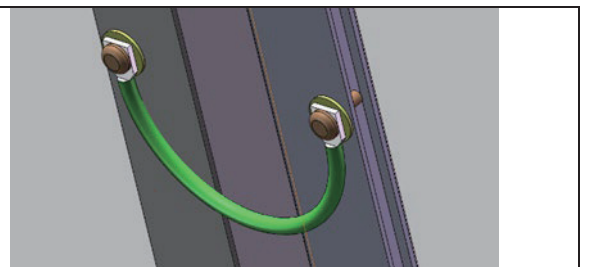

Thornova Solar recommends using the following methods to ground modules properly under UL investigation.

### Method 1: Tyco grounding bolt

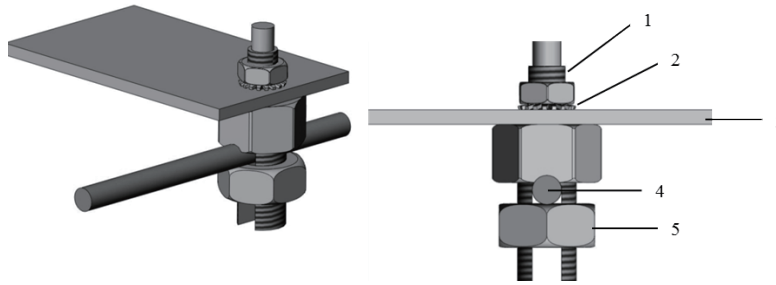

Figure 4. Tyco grounding bolt

- 1) Wire bolt and slot
- 2) Mounting wash hex nut
- 3) Aluminum frame
- 4) 0.006 to 0.025 in<sup>2</sup> cable
- 5) Hex Nut

Tyco grounding hardware comes in a package that includes the grounding bolt, mounting and grounding hex nut.

Electrical contact is made by penetrating the anodized coating of the aluminum frame, and tightening the mounting hex nut (come with the star washer) to the proper torque of 25lbf.in.

Grounding wire size (6 to 12 AWG solid bare copper) should be selected and installed underneath the wire binding bolt.

The wire binding bolt should be tightened to the proper torque of 45lbf.in.

### Method 2: Tyco grounding bolt

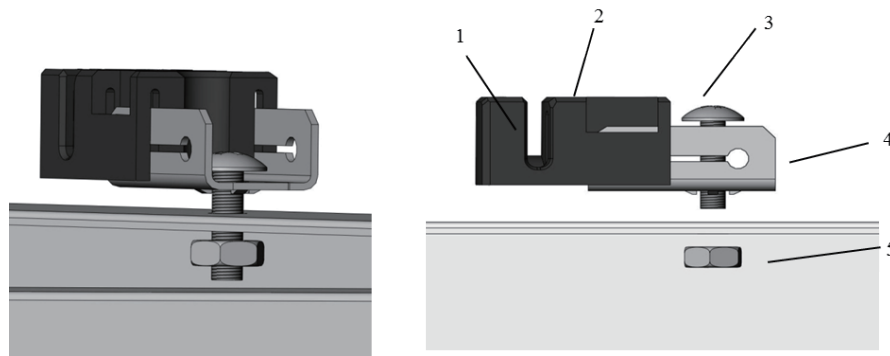

Figure 5. Tyco grounding bolt

- 1) Wire slot (available for 0.006 to 0.025in<sup>2</sup> cable)
- 2) Slider 3) Bolt 4) Base 5) Nut

Tyco grounding hardware comes in a package that includes the grounding bolt, mounting and grounding hex nut.

Electrical contact is made by penetrating the anodized coating of the aluminum frame, and tightening the mounting hex nut (come with the star washer) to the proper torque of 25lbf.in.

Grounding wire size (6 to 12 AWG solid bare copper) should be selected and installed underneath the wire binding bolt.

The wire binding bolt should be tightened to the proper torque of 45lbf.in.

The Tyco grounding bolt is only listed for use with 6 to 12 AWG bare solid copper wire.



### Method 3: ERICO grounding bolt

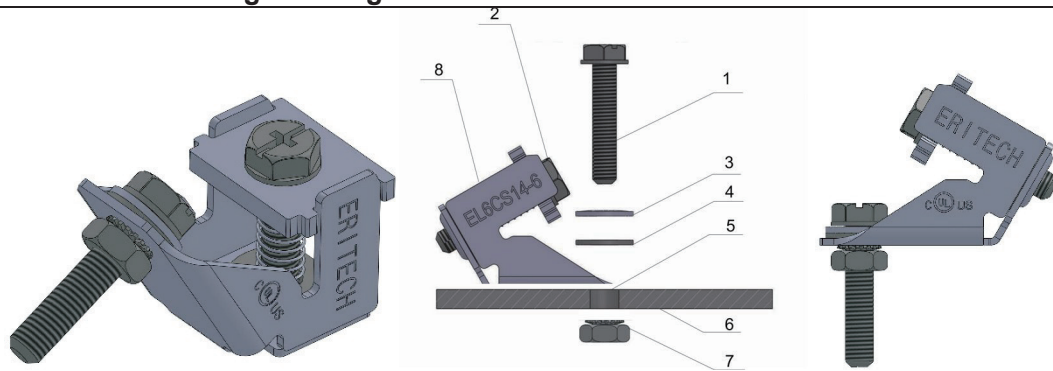

**Figure 6. ERICO grounding bolt**

- 1) Machine Bolt A
- 2) Machine Bolt B
- 3) Belleville washer
- 4) Flat Washer
- 5) Clearance hole for #10[M5] machine bolt
- 6) Aluminum frame
- 7) Machine box hex nut with lock washer
- 8) Grounding bolt

The lug should be installed on a surface that is larger than the bottom surface of the lug.

The lug should be installed in the grounding holes provided on the PV module.

Machine bolt A should be torqued to 35lbf.in, to secure the grounding bolt to module frame.

The grounding bolt is only listed for use with 6-12 AWG bare solid copper wire.

For proper wire binding, machine bolt B should be torqued to 35lbf.in.

### 5.2.3 ELECTRICAL INSTALLATION

All wiring should be performed, by qualified installers, in accordance with the local codes and regulations.

Modules can be connected in series to increase the operating voltage by plugging the positive plug of one module into the negative socket of the next. Before connecting modules always ensure that the contacts are corrosion free, clean and dry.

Product can be irreparably damaged if an array string is connected in reverse polarity to another. Always verify the voltage and polarity of each individual string before making a parallel connection. If you measure a reversed polarity or a difference of more than 10V between strings then check the string configuration before making the connection.

Thornova Solar modules are provided with stranded copper cables with a cross sectional area of 4mm<sup>2</sup>(0.006in<sup>2</sup>) which are UV resistant. All other cables used to connect the DC system should have a similar (or better) specification. Thornova Solar recommends that all cables are run in appropriate conduits and sited away from areas prone to water collection.

The maximum voltage of the system must be less than the maximum certified voltage and the maximum input voltage of the inverter and of the other electrical devices installed in the system. To ensure that this is the case, the open circuit voltage of the array string needs to be calculated at the lowest expected ambient temperature for the location. This can be done using the following formula.

$$\text{Max System voltage} \geq N * \text{Voc} * [1 + \text{TCvoc} * (\text{Tmin} - 25)]$$

Where

N        Number of modules in series

Voc      Open circuit voltage of each module (refer to product label or data sheet)

TCvoc   Thermal coefficient of open circuit voltage for the module (refer to data sheet)

Tmin    The lowest expected operating temperature of module

Each module has two industry standard 90°C sunlight resistant output cables, each terminated with plug & play connectors. The PV Wire cable and are 12AWG in size. This cable is suitable for applications where wiring is exposed to direct sunlight. Thornova Solar requires that all wiring and electrical connections comply with the appropriate National Electrical Code.

The minimum and maximum outer diameters of the cable are 5 to 7mm (0.038 to 0.076in).

For field connections, use at least 4mm<sup>2</sup> copper wires insulated for a minimum of 90°C and sunlight resistance with insulation designated as PV Wire.

The minimum bending radius of the cables must be 43mm (1.69in).

## 5.2.4 WIRING

To ensure proper system operation the correct cable connection polarity (Figures 1 & 2) should be observed when connecting the modules to each other or to a load, such as inverter, a battery etc. If modules were not connected correctly, the bypass diodes could be destroyed. PV modules can be wired in series to increase voltage. A series connection is made when the wire from the positive terminal of one module is connected to the negative terminal of the next module. Figure 1 shows modules connected in series. PV modules can be connected in parallel to increase current (Figure 2). A parallel connection is made when the wire from the positive terminal of one module is connected to the positive terminal on the next module.

The number of modules in series and in parallel shall be designed reasonably according to the system configuration.

All instructions above have to be obeyed to maintain Thornova Solar limited warranty

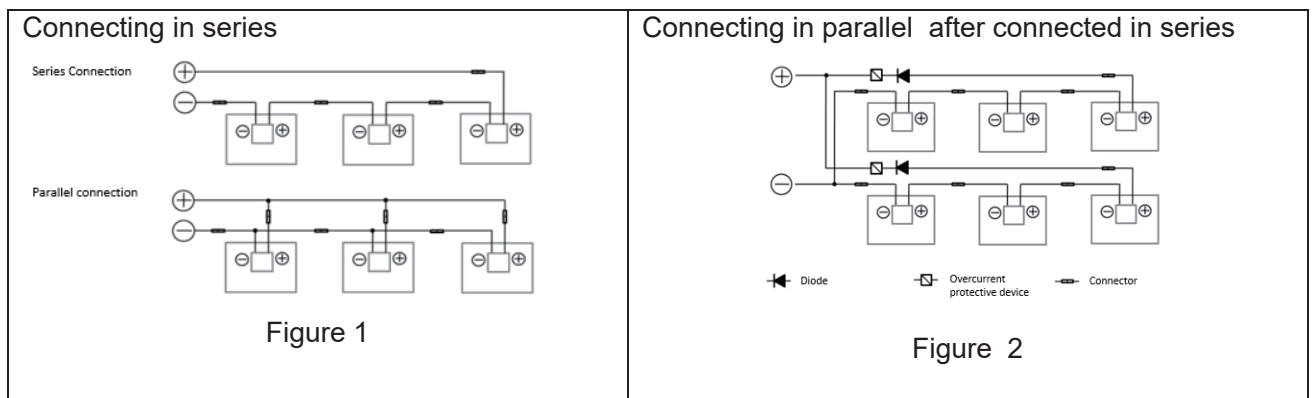

## 5.2.5 FUSING

When fuses are fitted they should be rated for the maximum DC voltage and connected in each, non-grounded pole of the array (i.e. if the system is not grounded then fuses should be connected in both the positive and negative poles).

The maximum rating of a fuse connected in series with an array string is typically 25A but the actual module specific rating can be found on the product label and in the product datasheet.

This fuse rating value also corresponds to the maximum reverse current that a module can withstand (when one string is shaded then the other parallel strings of modules will be loaded by the shaded string and current will flow) and therefore impacts the number of strings in parallel.

Do NOT share a fuse in a Combiner Box with two or more strings in parallel connection.

## 6. MODULE MAINTENANCE FOR PV MODULE PV

### 6.1 PANEL VISUAL INSPECTION AND REPLACEMENT

The modules in a PV array should be regularly checked for damage. Factors such as glass breakage, cable breakage, and junction box damage may lead to function and safety problems. In the case of a damaged module, replace it with the same type of module. Refer to the appropriate Product Installation

Manual for installation and dis-assembly of module.

It is recommended to perform a preventive inspection every six months without changing the components of the module. If electrical or mechanical appliances are used for inspection or maintenance, qualified professionals to avoid any electric shock or loss of life.

Trim any vegetation which may shade the solar array, thus impacting performance.

Check that mounting hardware is properly tightened.

Check that all string fuses in each non/earthed pole are operating.

Replacement modules must be of same type. Do NOT touch live parts of cables and connectors. Use appropriate safety equipment (insulated tools, insulating gloves, etc.) when handling modules.

Cover the front surface of modules by an opaque material when repairing. Modules when exposed to sunlight generate high voltage and are dangerous.

Thornova Solar PV modules are equipped with bypass diodes in the junction box. This minimizes module heating and current losses.

- Do NOT open the junction box to change the diodes even if they malfunction.
- In a system using a battery, blocking diodes are typically placed between the battery and the PV module output to prevent battery discharge at night.

In the event that a module is damaged (broken glass or a scratch on back sheet) and needs to be replaced.

- Observe the safety precautions listed earlier in this Manual
- Wear cut resistant gloves and other personal protective equipment required for the particular installation.
- Isolate the impacted array string to prevent current flow before attempting to remove the module.
- Disconnect the connectors of the affected module using the related disconnect tool provided by suppliers.
- Replace the damaged module with a new functional module of the same type.
- Check the open circuit voltage of the array string and verify that this is within 10V of the other strings to be connected in parallel.
- Turn the breaker back on.

## 6.2 CONNECTOR AND CABLE INSPECTION

Inspect all cables to verify that connections are tight, the cables are protected from direct sunlight and sited away from areas of water collection.

It is recommended to check the torque of terminal bolts and the general condition of wiring at least once a year. Also, check that mounting hardware is properly torqued. Loose connections will result in damage to the array.

## 6.3 CLEANING

The amount of electricity generated by a solar module is proportional to the amount of light falling on it. A module with shaded cells will produce less energy and therefore it is important to keep all PV modules clean.

Clean PV modules when the irradiance is below 200W/m<sup>2</sup>; liquid with a large temperature difference from the modules must not be used for cleaning the modules;

It is forbidden to clean PV modules under the weather conditions of wind more than 4 grades, heavy rain or heavy snow;

When cleaning with pressurized water, the water pressure on the glass surface of the module must not exceed 700 KPa (14619.80psf); the module must NOT bear the extra force;

When cleaning PV modules, do NOT step on the modules; do NOT spray water on the backside of the module or the cables; keep the connectors clean and dry; prevent fire and electrical shock from occurring; do NOT use as steam cleaner;

When cleaning the modules, use a soft cloth together with a mild detergent and clean water. Take care to avoid severe thermal shocks which might damage the module by cleaning modules with water which has a similar temperature to the modules being cleaned.

Use dry or wet soft clean cloth to clean the PV modules; use of non-corrosive solvents or hard objects are strictly prohibited;

If there is greasy dirt and other substances on the surface of the PV module which are difficult to clean, conventional household glass cleaning agents can be used; Do NOT use the alkaline and strong acid solvents.

The back surface of the module normally does not need to be cleaned but, in the event this is deemed necessary, avoid the use of any sharp projects that might damage the penetrating the substrate material.

When cleaning the back surface of the module, take care to avoid penetrating the substrate material. Modules that are mounted flat (0° tilt angle) should be cleaned more often, as they will NOT "self-clean" as effectively as modules mounted at a 10° tilt or greater.

If you are unsure whether the array or section there of needs to be cleaned, first select an array string that is particularly soiled, then

Measure & record the inverter feed in current from that string

- Clean all modules in the string
- Measure the inverter feed in current again and calculate the % improvement from cleaning

### **6.3.1 MODULE INSPECTION AFTER CLEANING**

Ensure that the module under visual inspection is clean, bright and free of stains;

Spot check to verify whether there is soot deposit on the module surface;

Check to see there are no visible scratches on the surface of the module;

Check to see there are no man-made cracks on the module surface;

Check to see whether the module support structure is leaning or bent after cleaning;

Check to see whether the wiring terminals of the module are detached;

After cleaning PV modules, fill out the PV module cleaning record.

### **6.3.2 TROUBLESHOOTING**

If your installation does not work properly, please inform your installer immediately. It is recommended to perform a preventive inspection every six months without changing the components of the modules. If electrical or mechanical properties are required for inspection or maintenance, qualified professionals should be advised to avoid any electric shock or loss of life

## **Attachment 1: SITE SELECTION and Title Angle**

Solar modules are recommended to be installed at an optimized tilt angle to maximize the energy output. It is roughly equal to the latitude of the project site as a rule of thumb, facing toward the equator. Optimized system designs must incorporate other local requirements.

When installing solar modules on a roof, the roof must be covered with a layer of fireproof material applicable to this class, and adequate ventilation must be ensured between the back sheet and the installation surface. A safe working area also must be left between the edge of the roof and the external edge of the solar array

In the case of residential installations on the ground, modules must be installed following local regulations, e.g. using fence.

Position the modules to minimize the chances of shading at all times of the day.

Thornova Solar recommends that the module should be installed at a working ambient temperature of  $-20^{\circ}\text{C}\sim 46^{\circ}\text{C}$ . The module's operating ambient temperature range is from  $-40^{\circ}\text{C}$  to  $85^{\circ}\text{C}$ .

Try to install modules in a location where there is rare shading throughout the year

If you are planning to use the PV modules where the water damage (Humidity:  $> 85\text{RH } \%$ ) may be possible, please consult with Thornova local technical support first to determine an appropriate installation method, or to determine whether the installation is possible.

If the module is installed in an area with frequent lightning and thunder, the module must be protected against lightning strikes. Please contact with local technical support or contact us from <http://www.thornovasolar.com>.

Make sure flammable gases are NOT generated near the installation site.

According to IEC 61701, salt mist corrosion testing of photovoltaic (PV), Thornova Solar modules can be installed in corrosive salt areas within proximity of the ocean or sulfuro us areas.

The module must not be soaked in the water or in the environment (i.e., fountain, spindrift, etc.) where the module would touch water (pure water or brine) for a long term. If the modules are placed in an environment of salt fog (i.e., marine environment) or sulfur (i.e., sulfur sources, volcanoes, etc.), there is a risk of corrosion .

In locations that are 50m ~ 500mm from the ocean, stainless steel or aluminum materials must be used to contact the PV modules, and the installation position must be processed with anti-corrosion treatment; Please contact with local technical support or contact us from <http://www.thornovasolarco m>

According to IEC62716:2013 “Ammonia corrosion testing of photovoltaic (PV) modules” and DLG Fokus testing for ammonia resistance, Thornova Solar modules can be safely installed in ammonia-heavy environments, such as farm houses.

According to the surrounding environment of the project, use the appropriate protective measures to ensure the safety of the module installation and reliable. For example, it needs to have around the windproof measures like design of windbreaks in strong wind area.

The system design needs to have the lightning protection function, it must pay more attention especially in the installation ground where are more lightning strike,

The tilt angle measurement of the PV module refers to measuring the angle between the module and the horizontal ground surface. For different projects there are different mounting angles. Thornova Solar recommends that the mounting tilt angle should be NOT less than  $10^{\circ}$ , or in accordance with local regulations or follow the recommendations of experienced PV module installers.

The tilt angle of the PV module is measured between the PV module and a horizontal ground surface.

In the Northern Hemisphere, the PV modules should typically face south, and in the Southern Hemisphere, the PV modules should typically face north.

A clearance of at least 115mm (4.5in) (recommended) is provided between modules and the surface of the wall or roof. If other mounting means are employed this may affect the UL Listing or the fire class ratings.

## Attachment 2: INVERTER SELECTION AND COMPATIBILITY

When installed in systems governed by local regulations, Thornova Solar modules normally do not need to be electronically connected to earth and therefore can be operated together with either galvanically isolated (with transformer) and transformerless inverters.

- Potential Induced Degradation (PID) is sometimes observed in PV modules due to a combination of high humidity, high temperature and high voltage. PID is most likely to cause degradation under the following conditions:
  - Installations in the warm and humid climates

- Installation close to a source of continual moisture, such as bodies of water
- To reduce the risk of PID, we strongly suggest that modules feature Thornova Solar Anti-PID technology, which can be applied to any Thornova product. Alternatively, we recommend the use of an inverter that includes a transformer as well as proper grounding of the negative DC leg of the PV array.

**THORNOVA** solar